

Solar charge inverter



USER MANUAL



HiS-3524 / HiS-5548 INVERTER / CHARGER

Table Of Contents

ABOUT THIS MANUAL	1
Purpose.....	1
Scope.....	1
SAFETY INSTRUCTIONS.....	1
INTRODUCTION	2
Features.....	2
Basic System Architecture	2
Product Overview.....	3
INSTALLATION	4
Unpacking and Inspection.....	4
Preparation	4
Mounting the Unit.....	4
Battery Connection	5
AC Input/Output Connection.....	7
PV Connection	8
Final Assembly.....	9
OPERATION	10
Power ON/OFF	10
Operation and Display Panel.....	10
LCD Display Icons	11
LCD Setting.....	13
Display Setting.....	20
Operating Mode Description	22
Fault Reference Code.....	26
Warning Indicator.....	27
Instructions for how to enter the display interface for lithium battery and turn the interface.	28
SPECIFICATIONS	31
Table 1 Line Mode Specifications	31
Table 2 Inverter Mode Specifications	32
Table 3 Charge Mode Specifications	33
Table 4 General Specifications	34
TROUBLE SHOOTING.....	35
Appendix: Approximate Back-up Time Table	36

ABOUT THIS MANUAL

Purpose

This manual describes the assembly, installation, operation and troubleshooting of this unit. Please read this manual carefully before installations and operations. Keep this manual for future reference.

Scope

This manual provides safety and installation guidelines as well as information on tools and wiring.

SAFETY INSTRUCTIONS



WARNING: This chapter contains important safety and operating instructions. Read and keep this manual for future reference.

1. Before using the unit, read all instructions and cautionary markings on the unit, the batteries and all appropriate sections of this manual.
2. **CAUTION** --To reduce risk of injury, charge only deep-cycle lead acid type rechargeable batteries. Other types of batteries may burst, causing personal injury and damage.
3. Do not disassemble the unit. Take it to a qualified service center when service or repair is required. Incorrect re-assembly may result in a risk of electric shock or fire.
4. To reduce risk of electric shock, disconnect all wirings before attempting any maintenance or cleaning. Turning off the unit will not reduce this risk.
5. **CAUTION** – Only qualified personnel can install this device with battery.
6. **NEVER** charge a frozen battery.
7. For optimum operation of this inverter/charger, please follow required spec to select appropriate cable size. It's very important to correctly operate this inverter/charger.
8. Be very cautious when working with metal tools on or around batteries. A potential risk exists to drop a tool to spark or short circuit batteries or other electrical parts and could cause an explosion.
9. Please strictly follow installation procedure when you want to disconnect AC or DC terminals. Please refer to INSTALLATION section of this manual for the details.
10. Fuses (1piece of 200A, 32VDC for HiS-3524, 1piece of 200A, 58VDC for HiS-5548) are provided as over-current protection for the battery supply.
11. GROUNDING INSTRUCTIONS -This inverter/charger should be connected to a permanent grounded wiring system. Be sure to comply with local requirements and regulation to install this inverter.
12. **NEVER** cause AC output and DC input short circuited. Do NOT connect to the mains when DC input short circuits.
13. **Warning!!** Only qualified service persons are able to service this device. If errors still persist after following troubleshooting table, please send this inverter/charger back to local dealer or service center for maintenance.

INTRODUCTION

This is a multi-function inverter/charger, combining functions of inverter, MPPT solar charger and battery charger to offer uninterruptible power support with portable size. Its comprehensive LCD display offers user-configurable and easy-accessible button operation such as battery charging current, AC/solar charger priority, and acceptable input voltage based on different applications.

Features

- Pure sine wave output
- Output power factor 1.0
- Programmable supply priority for PV ,battery or Grid
- User-adjustable charge current and voltage
- Wide PV input range (120Vdc -500Vdc),110A MPPT SCC
- Working without batteries in sunny day
- WiFi Monitoring Function (optional)
- Anti-dusk kit for harsh environment(optional)
- LCD remote control with 10 meters wire(optional)
- PV and electricity complementary
- Use with lithium batteries

Basic System Architecture

The following illustration shows basic application for this inverter/charger. It also includes following devices to have a complete running system:

- Generator or Utility.
- PV modules (option)

Consult with your system integrator for other possible system architectures depending on your requirements.

This inverter can power all kinds of appliances in home or office environment, including motor-type appliances such as tube light, fan, refrigerator and air conditioner.

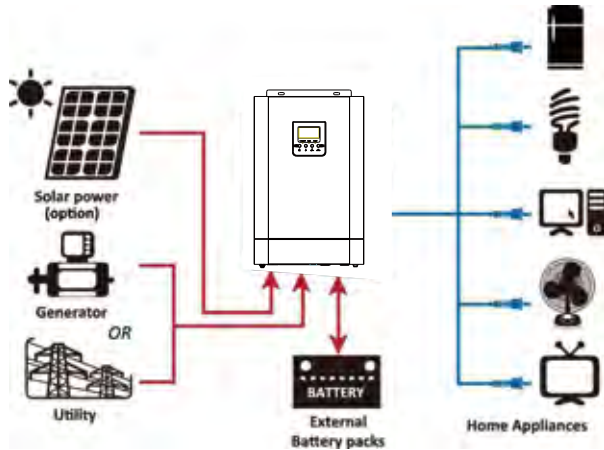
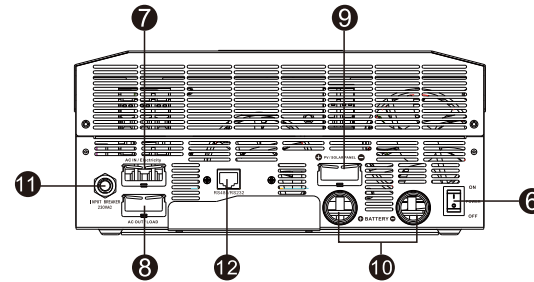
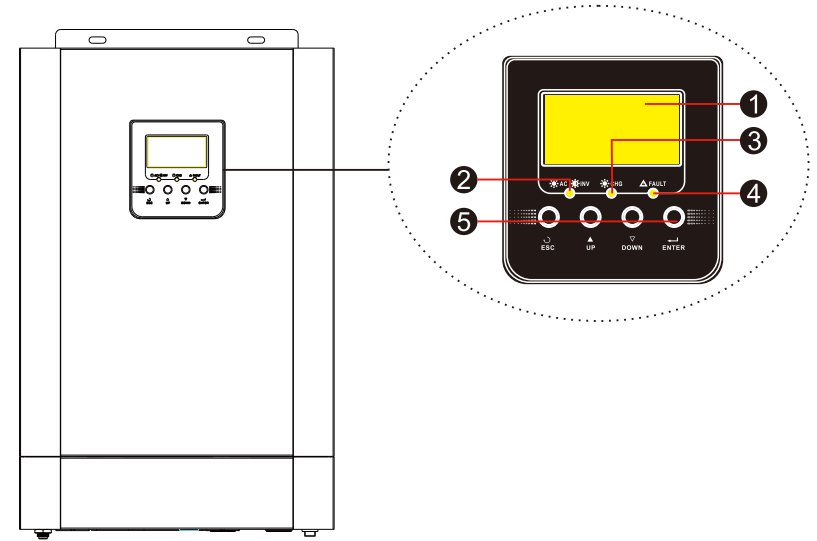

Figure 1 Hybrid Power System

Product Overview



1. LCD display
2. Status indicator
3. Charging indicator
4. Fault indicator
5. Function buttons
6. Power on/off switch
7. AC input
8. AC output
9. PV input
10. Battery input
11. Circuit breaker
12. RS485/RS232 communication port

INSTALLATION

Unpacking and Inspection

Before installation, please inspect the unit. Be sure that nothing inside the package is damaged. You should have received the following items inside of package:

- The unit x 1
- User manual x 1
- Communication cable x 1

Preparation

Before connecting all wirings, please take off bottom cover by removing two screws as shown below.

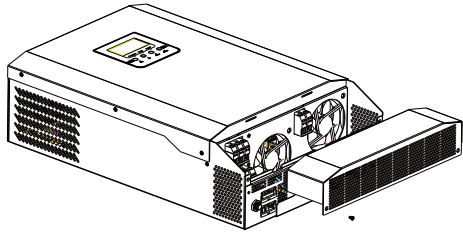

Mounting the Unit

Consider the following points before selecting where to install:

- Do not mount the inverter on flammable construction materials.
- Mount on a solid surface
- Install this inverter at eye level in order to allow the LCD display to be read at all times.
- The ambient temperature should be between 0°C and 55°C to ensure optimal operation.
- The recommended installation position is to be adhered to the wall vertically.
- Be sure to keep other objects and surfaces as shown in the right diagram to guarantee sufficient heat dissipation and to have enough space for removing wires.

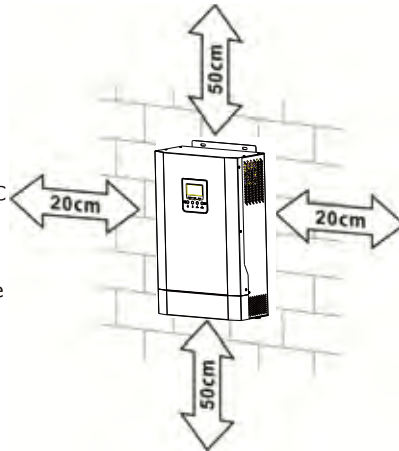

⚠ SUITABLE FOR MOUNTING ON CONCRETE OR OTHER NON-COMBUSTIBLE SURFACE ONLY.

Install the unit by screwing two screws.



Battery Connection

CAUTION: For safety operation and regulation compliance, it's requested to install a separate DC over-current protector or disconnect device between battery and inverter. It may not be requested to have a disconnect device in some applications, however, it's still requested to have over-current protection installed. Please refer to typical amperage in below table as required fuse or breaker size.

WARNING! All wiring must be performed by a qualified personnel.

WARNING! It's very important for system safety and efficient operation to use appropriate cable for battery connection. To reduce risk of injury, please use the proper recommended cable and terminal size as below.

Ring terminal:

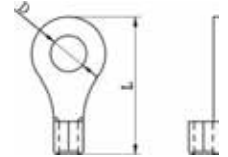

Recommended battery cable and terminal size:

Model	Typical Amperage	Battery Capacity	Wire Size	Ring Terminal			Torque Value
				Cable mm ²	Dimensions		
				D (mm)	L (mm)		
HiS-3524	145A	100AH	1*3AWG	22	6.4	33.2	2~ 3 Nm
		200AH	2*6AWG	14	6.4	29.2	
HiS-5548	115A	200AH	1*4AWG	22	6.4	33.2	2~ 3 Nm
			2*8AWG	14	6.4	29.2	

Please follow below steps to implement battery connection:

1. Assemble battery ring terminal based on recommended battery cable and terminal size.
2. Connect all battery packs as units requires.

NOTE: Please only use sealed lead acid battery or sealed GEL/AGM lead-acid battery.

3. Insert the ring terminal of battery cable flatly into battery connector of inverter and make sure the bolts are tightened with torque of 2-3 Nm. Make sure polarity at both the battery and the inverter/charge is correctly connected and ring terminals are tightly screwed to the battery terminals.

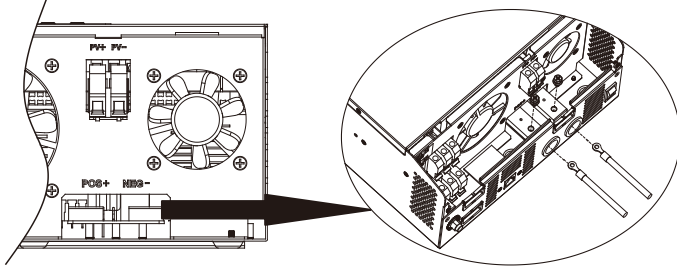

AC Input/Output Connection

CAUTION!! Before connecting to AC input power source, please install a **separate** AC breaker between inverter and AC input power source. This will ensure the inverter can be securely disconnected during maintenance and fully protected from over current of AC input. The recommended spec of AC breaker is for 32A for HiS-3524, 50A for HiS-5548.

CAUTION!! There are two terminal blocks with "IN" and "OUT" markings. Please do NOT mis-connect input and output connectors.

WARNING! All wiring must be performed by a qualified personnel.

WARNING! It's very important for system safety and efficient operation to use appropriate cable for AC input connection. To reduce risk of injury, please use the proper recommended cable size as below.

Suggested cable requirement for AC wires

Model	Gauge	Torque Value
HiS-3524	12 AWG	1.2~ 1.6 Nm
HiS-5548	8 AWG	1.4~ 1.6Nm

Please follow below steps to implement AC input/output connection:

1. Before making AC input/output connection, be sure to open DC protector or disconnecter first.
2. Remove insulation sleeve 10mm for six conductors. And shorten phase L and neutral conductor N 3 mm.
3. Insert AC input wires according to polarities indicated on terminal block and tighten the terminal screws. Be sure to connect PE protective conductor (⊕) first.

⊕→**Ground (yellow-green)**

L→**LINE (brown or black)**

N→**Neutral (blue)**

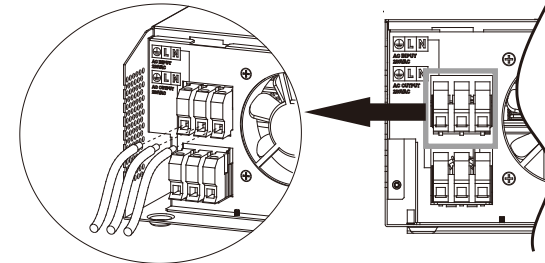

WARNING:

Be sure that AC power source is disconnected before attempting to hardwire it to the unit.

4. Then, insert AC output wires according to polarities indicated on terminal block and tighten terminal screws. Be sure to connect PE protective conductor (⊕) first.

⊕→**Ground (yellow-green)**

L→**LINE (brown or black)**

N→**Neutral (blue)**

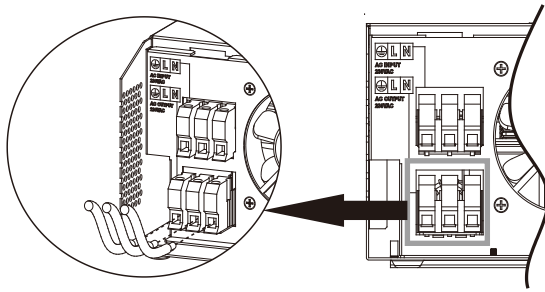

5. Make sure the wires are securely connected.

CAUTION: Important

Be sure to connect AC wires with correct polarity. If L and N wires are connected reversely, it may cause utility short-circuited when these inverters are worked in parallel operation.

CAUTION: Appliances such as air conditioner are required at least 2~3 minutes to restart because it's required to have enough time to balance refrigerant gas inside of circuits. If a power shortage occurs and recovers in a short time, it will cause damage to your connected appliances. To prevent this kind of damage, please check manufacturer of air conditioner if it's equipped with time-delay function before installation. Otherwise, this inverter/charger will trig overload fault and cut off output to protect your appliance but sometimes it still causes internal damage to the air conditioner.

PV Connection

CAUTION: Before connecting to PV modules, please install **separately** a DC circuit breaker between inverter and PV modules.

WARNING! All wiring must be performed by a qualified personnel.

WARNING! It's very important for system safety and efficient operation to use appropriate cable for PV module connection. To reduce risk of injury, please use the proper recommended cable size as below.

Model	Wire Size	Cable (mm ²)	Torque value (max)
HiS-3524/HiS-5548	1 x 12AWG	4	1.2 Nm

PV Module Selection:

When selecting proper PV modules, please be sure to consider below parameters:

1. Open circuit Voltage (Voc) of PV modules not exceeds max. PV array open circuit voltage of inverter.
2. Open circuit Voltage (Voc) of PV modules should be higher than min. battery voltage.

INVERTER MODEL	HiS-3524	HiS-5548
Max. PV Array Open Circuit Voltage	500Vdc	
PV Array MPPT Voltage Range	120Vdc~450Vdc	

Take 250Wp PV module as an example. After considering above two parameters, the recommended module configurations are listed as below table.

Solar Panel Spec. (reference)	SOLAR INPUT		Q'ty of panels	Total input power
	(Min in serial: 6 pcs, max. in serial: 13 pcs)			
- 250Wp				
- Vmp: 30.1Vdc	6 pcs in serial		6 pcs	1500W
- Imp: 8.3A	8 pcs in serial		8 pcs	2000W
- Voc: 37.7Vdc	12 pcs in serial		12 pcs	3000W
- Isc: 8.4A	13 pcs in serial		13 pcs	3250W
- Cells: 60	8 pieces in serial and 2 sets in parallel		16 pcs	4000W
	10 pieces in serial and 2 sets in parallel		20 pcs	5000W

Please follow below steps to implement PV module connection:

1. Remove insulation sleeve 10 mm for positive and negative conductors.
2. Check correct polarity of connection cable from PV modules and PV input connectors. Then, connect positive pole (+) of connection cable to positive pole (+) of PV input connector. Connect negative pole (-) of connection cable to negative pole (-) of PV input connector.

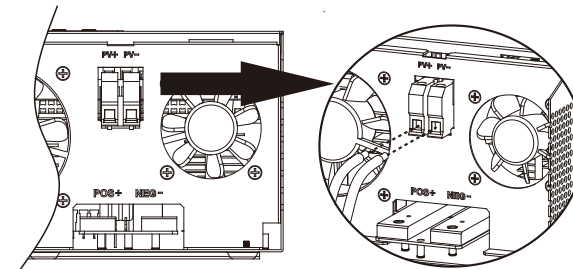

3. Make sure the wires are securely connected.

Final Assembly

After connecting all wirings, please put bottom cover back by screwing two screws as shown below.

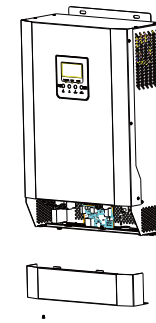

OPERATION

Power ON/OFF

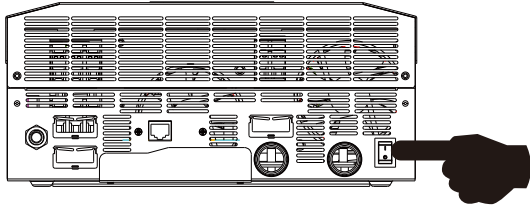

Once the unit has been properly installed and the batteries are connected well, simply press On/Off switch (located on the button of the case) to turn on the unit.

Operation and Display Panel

The operation and display panel, shown in below chart, is on the front panel of the inverter. It includes three indicators, four function keys and a LCD display, indicating the operating status and input/output power information.

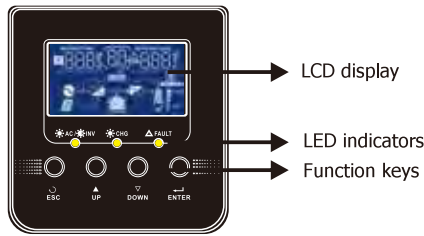

LED Indicator

LED Indicator		Messages	
AC/INV	Green	Solid On	Output is powered by utility in Line mode.
		Flashing	Output is powered by battery or PV in battery mode.
CHG	Green	Solid On	Battery is fully charged.
		Flashing	Battery is charging.
FAULT	Red	Solid On	Fault occurs in the inverter.
		Flashing	Warning condition occurs in the inverter.

Function Keys

Function Key	Description
ESC	To exit setting mode
UP	To go to previous selection
DOWN	To go to next selection
ENTER	To confirm the selection in setting mode or enter setting mode

LCD Display Icons

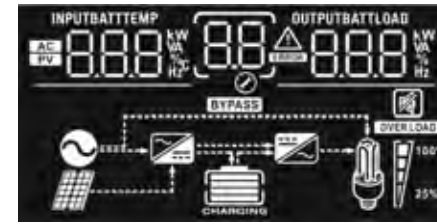

Icon	Function description	
Input Source Information		
AC	Indicates the AC input.	
PV	Indicates the PV input	
INPUTBATT 8.8.8 V Hz	Indicate input voltage, input frequency, PV voltage, battery voltage and charger current.	
Configuration Program and Fault Information		
88	Indicates the setting programs.	
88	Indicates the warning and fault codes.	
88	Warning: 88 flashing with warning code.	
88	Fault: 88 lighting with fault code	
Output Information		
OUTPUTBATLOAD 8.8.8 V Hz	Indicate output voltage, output frequency, load percent, load in VA, load in Watt and discharging current.	
Battery Information		
CHARGING	Indicates battery level by 0-24%, 25-49%, 50-74% and 75-100% in battery mode and charging status in line mode.	
In AC mode, it will present battery charging status.		
Status	Battery voltage	LCD Display
Constant Current mode / Constant Voltage mode	<2V/cell	4 bars will flash in turns.
	2 ~ 2.083V/cell	Bottom bar will be on and the other three bars will flash in turns.
	2.083 ~ 2.167V/cell	Bottom two bars will be on and the other two bars will flash in turns.
Voltage mode	> 2.167 V/cell	Bottom three bars will be on and the top bar will flash.
	Floating mode. Batteries are fully charged.	4 bars will be on.

In battery mode, it will present battery capacity.

Load Percentage	Battery Voltage	LCD Display
Load >50%	< 1.717V/cell	
	1.717V/cell ~ 1.8V/cell	
	1.8 ~ 1.883V/cell	
	> 1.883 V/cell	
50%> Load > 20%	< 1.817V/cell	
	1.817V/cell ~ 1.9V/cell	
	1.9 ~ 1.983V/cell	
	> 1.983	
Load < 20%	< 1.867V/cell	
	1.867V/cell ~ 1.95V/cell	
	1.95 ~ 2.033V/cell	
	> 2.033	

Load Information

	Indicates overload.			
	Indicates the load level by 0-24%, 25-50%, 50-74% and 75-100%.			
	0%~25%	25%~50%	50%~75%	75%~100%

Mode Operation Information

	Indicates unit connects to the mains.
	Indicates unit connects to the PV panel.
	Indicates load is supplied by utility power.
	Indicates the utility charger circuit is working.
	Indicates the DC/AC inverter circuit is working.

Mute Operation

	Indicates unit alarm is disabled.
--	-----------------------------------

LCD Setting











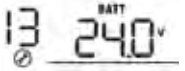



After pressing and holding ENTER button for 3 seconds, the unit will enter setting mode. Press "UP" or "DOWN" button to select setting programs. And then, press "ENTER" button to confirm the selection or ESC button to exit.

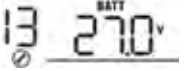
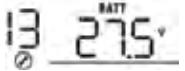

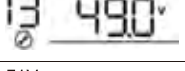
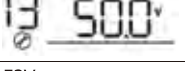
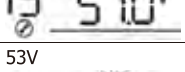
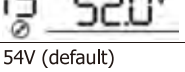
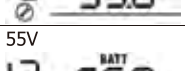
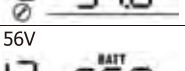
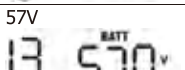
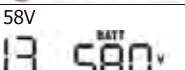

Setting Programs:

Program	Description	Selectable option
00	Exit setting mode	Escape
01	Output source priority: To configure load power source priority	 Solar energy provides power to the loads as first priority. If solar energy is out sufficient to power all connected loads, utility energy will supply power to the loads at the same time.
		 Solar energy provides power to the loads as first priority. If solar energy is not sufficient to power all connected loads, battery energy will supply power to the loads at the same time. Utility provides power to the loads only when battery voltage drops to either low-level warning voltage or the setting point in program 12.
02	Maximum charging current To configure total charging current for solar and utility chargers. (Max. charging current = utility charging current + solar charging current)	10A
		20A
		30A
		40A
		50A
		60A
		70A
80A 		
90A 		
100A 		
110A 		

03	AC input voltage range	Appliances (default) 03 APL	If selected, acceptable AC input voltage range will be within 90-280VAC.
		UPS 03 UPS	If selected, acceptable AC input voltage range will be within 170-280VAC.
04	Power saving mode enable/disable	Saving mode disable (default) 04 SdS	If disabled, no matter connected load is low or high, the on/off status of inverter output will not be effected.
		Saving mode enable 04 SEN	If enabled, the output of inverter will be off when connected load is pretty low or not detected.
05	Battery type	AGM (default) 05 AGM	Flooded 05 FLd
		User-Defined 05 USE	If "User-Defined" is selected, battery charge voltage and low DC cut-off voltage can be set up in program 26, 27 and 29.
06	Auto restart when overload occurs	Restart disable (default) 06 LtD	Restart enable 06 LfE
07	Auto restart when over temperature occurs	Restart disable (default) 07 tD	Restart enable 07 tE
08	Output voltage	220V 08 220 ^v	230V (default) 08 230 ^v
		240V 08 240 ^v	
09	Output frequency	50Hz (default) 09 50 ^{Hz}	60Hz 09 60 ^{Hz}

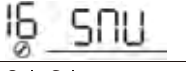
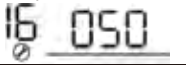
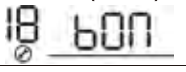
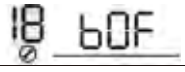
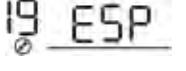
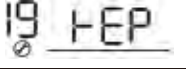
11	Maximum utility charging current	2A 11 2A	10A 11 10A
		20A 11 20A	30A 11 30A
		40A 11 40A	50A 11 50A
		60A 11 60A	70A 11 70A
		80A 11 80A	
		12	Setting voltage point back to utility source when selecting "SBU priority"
22.0V 12 22.0 ^v	22.5V 12 22.5 ^v		
23.0V (default) 12 23.0 ^v	23.5V 12 23.5 ^v		
24.0V 12 24.0 ^v	24.5V 12 24.5 ^v		
25.0V 12 25.0 ^v	25.5V 12 25.5 ^v		
Available options in 48V models:			
44V 12 44 ^v	45V 12 45 ^v		
46V (default) 12 46 ^v	47V 12 47 ^v		
48V 12 48 ^v	49V 12 49 ^v		
50V 12 50 ^v	51V 12 51 ^v		

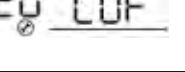
13	Setting voltage point back to battery mode when selecting "SBU priority"	Available options in 24V models:	
		Battery fully charged	24V
			
		24.5V	25V
			
		25.5V	26V
			
		26.5V	27V (default)
			
		27.5V	28V
			
		28.5V	29V
			
		Available options in 48V models:	
		Battery fully charged	48V
			
49V	50V		
			
51V	52V		
			
53V	54V (default)		
			
55V	56V		
			
57V	58V		
			

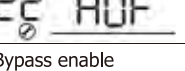
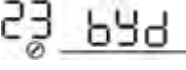
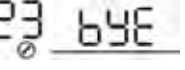
16	Charger source priority: To configure charger source priority	If this inverter/charger is working in Line, Standby or Fault mode, charger source can be programmed as below:	
		Solar first 	Solar energy will charge battery as first priority. Utility will charge battery only when solar energy is not available.
		Solar and Utility 	Solar energy and utility will charge battery at the same time.
		Only Solar 	Solar energy will be the only charger source no matter utility is available or not.
		If this inverter/charger is working in Battery mode or Power saving mode, only solar energy can charge battery. Solar energy will charge battery if it's available and sufficient.	
18	Alarm control	Alarm on (default) 	Alarm off 
19	Auto return to default display screen	Return to default display screen (default) 	If selected, no matter how users switch display screen, it will automatically return to default display screen (Input voltage /output voltage) after no button is pressed for 1 minute.
		Stay at latest screen 	If selected, the display screen will stay at latest screen user finally switches.
20	Backlight control	Backlight on (default) 	Backlight off 
22	Beeps while primary source is interrupted	Alarm on (default) 	Alarm off 
23	Overload bypass: When enabled, the unit will transfer to line mode if overload occurs in battery mode.	Bypass disable (default) 	Bypass enable 

25	Record Fault code	Record enable 25 FEN	Record disable (default) 25 FdS
26	Bulk charging voltage (C.V voltage)	24V model default setting: 28.2V CU 26 28.2 ^{BATT}	
		48V model default setting: 56.4V CU 26 56.4 ^{BATT}	
		If self-defined is selected in program 5, this program can be set up. Setting range is from 24.0V to 29.2V for 24V model and 48.0V to 58.4V for 48V model. Increment of each click is 0.1V.	
27	Floating charging voltage	24V model default to 27.0V FLU 27 27.0 ^{BATT}	
		48V model default setting: 54.0V FLU 27 54.0 ^{BATT}	
		If self-defined is selected in program 5, this program can be set up. Setting range is from 24.0V to 29.2V for 24V model, 48.0V to 58.4V for 48V model. Increment of each click is 0.1V.	
29	Low DC cut-off voltage	24V model default setting: 21.0V COU 29 21.0 ^{BATT}	
		48V model default setting: 42.0V COU 29 42.0 ^{BATT}	
		If self-defined is selected in program 5, this program can be set up. Setting range is from 20.0V to 24.0V for 24V model, 40.0V to 48.0V for 48V model. Increment of each click is 0.1V. Low DC cut-off voltage will be fixed to setting value no matter what percentage of load is connected.	
31	Solar power balance: When enabled, solar input power will be automatically adjusted according to connected load power	Solar power balance: enable (Default): 31 56E	if selected, solar input power will be automatically adjusted according to the following formula: Max. input solar power = Max. battery charging power + Connected load power.



33	Battery equalization	33 EEN		33 EdS	
		If "Flooded" or "User-Defined" is selected in program 05, this program can be set up.			
34	Battery equalization voltage	1KVA default setting: 14.6V EU 34 14.6 ^{BATT}			
		Setting range is from 12.5V to 15 V. Increment of each click is 0.1V.			
		2/3KVA default setting: 29.2V EU 34 29.2 ^{BATT}			
		Setting range is from 25.0V to 29.5V. Increment of each click is 0.1V.			
		4/5KVA default setting: 58.4V EU 34 58.4 ^{BATT}			
		Setting range is from 50 to 59 V. Increment of each click is 0.1V.			
35	Battery equalized time	60min (default) 35 60	Setting range is from 5min to 900min. Increment of each click is 5min.		
36	Battery equalized timeout	120min (default) 36 120	Setting range is from 5min to 900 min. Increment of each click is 5 min.		
37	Equalization interval	30days (default) 37 30d	Setting range is from 0 to 90 days. Increment of each click is 1 day		
39	Equalization activated immediately	Enable 39 AEN		Disable (default) 39 AdS	
		If equalization function is enabled in program 33, this program can be set up. If "Enable" is selected in this program, it's to activate battery equalization immediately and LCD main page will shows "E9". If "Disable" is selected, it will cancel equalization function until next activated equalization time arrives based on program 37 setting. At this time "E9" will not be shown in LCD main page.			

Display Setting





The LCD display information will be switched in turns by pressing "UP" or "DOWN" key. The selectable information is switched as below order: input voltage, input frequency, PV voltage, MPPT charging current, MPPT charging power, battery voltage, output voltage, output frequency, load percentage, load in VA, load in Watt, DC discharging current, main CPU Version and second CPU Version.



Selectable information	LCD display
Input voltage/Output voltage (Default Display Screen)	<p>Input Voltage=230V, output voltage=230V</p>
Input frequency	<p>Input frequency=50Hz</p>
PV voltage	<p>PV voltage=360V</p>
MPPT Charging current	<p>Current \geq 10A</p> <p>Current < 10A</p>



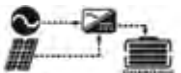
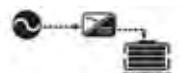

MPPT Charging power	<p>MPPT charging power=500W</p>
Battery voltage/ DC discharging current	<p>Battery voltage=25.5V, discharging current=1A</p>
Output frequency	<p>Output frequency=50Hz</p>
Load percentage	<p>Load percent=70%</p>
Load in VA	<p>When connected load is lower than 1kVA, load in VA will present xxxVA like below chart.</p> <p>When load is larger than 1kVA, load in VA will present x.xkVA like below chart.</p>

Load in Watt	<p>When load is lower than 1kW, load in W will present xxxW like below chart.</p>  <p>When load is larger than 1kW, load in W will present x.xkW like below chart.</p> 
Main CPU version checking	<p>Main CPU version 00014.04</p> 

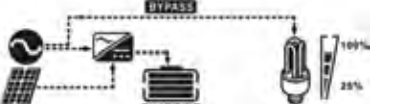
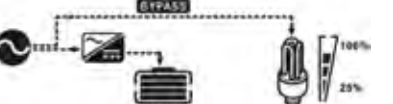
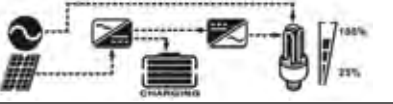
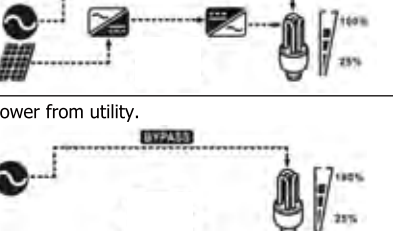
Operating Mode Description

Operation mode	Description	LCD display
Standby mode / Power saving mode Note: *Standby mode: The inverter is not turned on yet but at this time, the inverter can charge battery without AC output. *Power saving mode: If enabled, the output of inverter will be off when connected load is pretty low or not detected.	No output is supplied by the unit but it still can charge batteries.	Charging by utility and PV energy. 
		Charging by utility. 
		Charging by PV energy. 
		No charging. 

Fault mode Note: *Fault mode: Errors are caused by inside circuit error or external reasons such as over temperature, output short circuited and so on.	PV energy and utility can charge batteries.	Charging by utility and PV energy. 
		Charging by utility. 
		Charging by PV energy. 
		No charging. 
Line Mode	The unit will provide output power from the mains. It will also charge the battery at line mode.	Charging by utility and PV energy. 
	The unit will provide output power from the mains. It will also charge the battery at line mode.	Charging by utility. 
	The unit will provide output power from the mains. It will also charge the battery at line mode.	If "SUB" is selected as output source priority and solar energy is not sufficient to provide the load, solar energy and the utility will provide the loads and charge the battery at the same time. 
	The unit will provide output power from the mains. It will also charge the battery at line mode.	If "SUB" is selected as output source priority and battery is not connected, solar energy and the utility will provide the loads. Power from utility. 

Battery Mode	The unit will provide output power from battery and PV power.	Power from battery and PV energy. 
		PV energy will supply power to the loads and charge battery at the same time. 
		Power from battery only. 
		Power from PV energy only. 

Battery Equalization Description

Equalization function is added into charge controller. It reverses the buildup of negative chemical effects like stratification, a condition where acid concentration is greater at the bottom of the battery than at the top. Equalization also helps to remove sulfate crystals that might have built up on the plates. If left unchecked, this condition, called sulfation, will reduce the overall capacity of the battery. Therefore, it's recommended to equalize battery periodically.

- **How to Apply Equalization Function**

You must enable battery equalization function in monitoring LCD setting program 33 first. Then, you may apply this function in device by either one of following methods:

1. Setting equalization interval in program 34.
2. Active equalization immediately in program 39.

- **When to Equalize**

In float stage, when the setting equalization interval (battery equalization cycle) is arrived, or equalization is active immediately, the controller will start to enter Equalize stage.

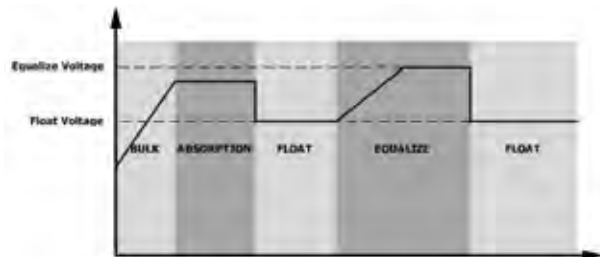

- **Equalize charging time and timeout**

In Equalize stage, the controller will supply power to charge battery as much as possible until battery voltage raises to battery equalization voltage. Then, constant-voltage regulation is applied to maintain battery voltage at the battery equalization voltage. The battery will remain in the Equalize stage until setting battery equalized time is arrived.

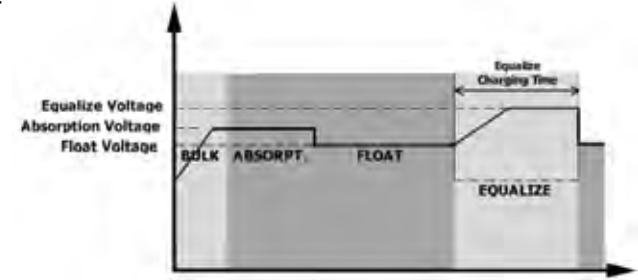

However, in Equalize stage, when battery equalized time is expired and battery voltage doesn't rise to battery equalization voltage point, the charge controller will extend the battery equalized time until battery voltage achieves battery equalization voltage. If battery voltage is still lower than battery equalization voltage when battery equalized timeout setting is over, the charge controller will stop equalization and return to float stage.

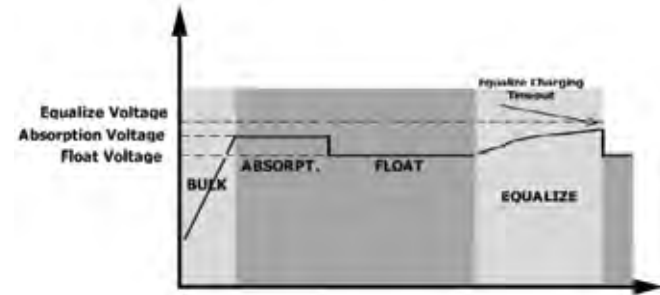

Fault Reference Code

Fault Code	Fault Event	Icon on
01	Fan is locked when inverter is off.	
02	Over temperature	
03	Battery voltage is too high	
04	Battery voltage is too low	
05	Output short circuited or over temperature is detected by internal converter components.	
06	Output voltage is too high.	
07	Overload time out	
08	Bus voltage is too high	
09	Bus soft start failed	
11	Main relay failed	
51	Over current or surge	
52	Bus voltage is too low	
53	Inverter soft start failed	
55	Over DC voltage in AC output	
56	Battery connection is open	
57	Current sensor failed	
58	Output voltage is too low	

Warning Indicator

Warning Code	Warning Event	Audible Alarm	Icon flashing
01	Fan is locked when inverter is on.	Beep three times every second	
03	Battery is over-charged	Beep once every second	
04	Low battery	Beep once every second	
07	Overload	Beep once every 0.5 second	
10	Output power derating	Beep twice every 3 seconds	
12	Solar charger stops due to low battery.		
13	Solar charger stops due to high PV voltage.		
14	Solar charger stops due to overload.		
15	PV is weak		
19	Battery is not connected		

Instructions for how to enter the display interface for lithium battery and turn the interface.

Pin number	Port definitions
1	TX
2	RX
3	VCC
4	VCC
5	RS485A
6	RS485B
7	GND
8	GND

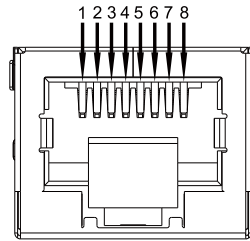

Communication port pin definition

1. Long press ENTER key to enter the setting item and set the 05 item to lithium battery mode Lib (as shown in the figure below).



2. Long press the ESC key to enter the lithium battery display interface (as shown in the picture below)

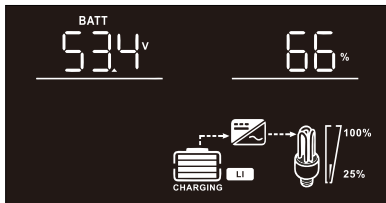

The initial display interface indicate the total battery voltage and remaining battery capacity

Press the DOWN key to indicate the data as below in turn

LCD data on the left	LCD data on the right	instruction
Total battery voltage	Remaining battery capacity	
Battery charging current	Battery discharge current	
Battery capacity	Battery charge/discharge times	Warning in the middle
BMS board temperature	Mosfet temperature of BMS board	
Maximum voltage of a single battery cell	Minimum voltage of a single battery cell	
Maximum temperature of a single battery cell	Minimum temperature of a single battery cell	

3. Detailed description of display interface for lithium battery

Total battery voltage; Battery remaining capacity (Initial interface display)	Total battery voltage=50.5V Battery residual capacity=4%
Battery charging current; Battery discharge current	Battery charging current= 0A Battery discharge current=21A
Battery capacity; Battery charger/discharge Times	Battery capacity=100Ah Battery charger/discharge Times=4
BMS board temperature; Mosfet temperature of BMS board	Battery ambient temperature=25.9°C Battery MOS temperature=25.7°C
Maximum voltage of a single battery cell; Minimum voltage of a single battery cell;	Maximum voltage of a single battery cell=3.20V Minimum voltage of a single battery cell=3.10V
Maximum temperature of a single battery cell; Minimum temperature of a single battery cell;	Maximum temperature of a single battery cell=25.0°C Minimum temperature of a single battery cell=24.2°C

4.Warning Code

Warning Code	Warning Event	Warning Event
21	Battery cell over voltage	21 [△]
22	Battery cell low voltage	22 [△]
23	Battery pack over voltage	23 [△]
24	Battery pack low voltage	24 [△]
25	Charging over current	25 [△]
26	Discharging over current	26 [△]
27	Charging cell high temperature	27 [△]
28	Discharging cell high temperature	28 [△]
29	Charging cell low temperature	29 [△]
30	Discharging cell low temperature	30 [△]
31	Environment high temperature	31 [△]
32	Environment low temperature	32 [△]
33	MOSFET high temperature	33 [△]

5.Falut Code

Falut Code	Warning Event	Warning Event
21	Battery cell over voltage	21 ^{故障}
22	Battery cell low voltage	22 ^{故障}
23	Battery pack over voltage	23 ^{故障}
24	Battery pack low voltage	24 ^{故障}
25	Charging over current	25 ^{故障}
26	Discharging over current	26 ^{故障}
27	Charging cell high temperature	27 ^{故障}
28	Discharging cell high temperature	28 ^{故障}
29	Charging cell low temperature	29 ^{故障}
30	Discharging cell low temperature	30 ^{故障}
31	Environment high temperature	31 ^{故障}
32	Environment low temperature	32 ^{故障}
33	MOSFET high temperature	33 ^{故障}
35	Short circuit	35 ^{故障}
36	Charger over voltage	36 ^{故障}

SPECIFICATIONS

Table 1 Line Mode Specifications

INVERTER MODEL	HiS-3524	HiS-5548
Input Voltage Waveform	Sinusoidal (utility or generator)	
Nominal Input Voltage	230Vac	
Low Loss Voltage	170Vac±7V (UPS) 90Vac±7V (Appliances)	
Low Loss Return Voltage	180Vac±7V (UPS); 100Vac±7V (Appliances)	
High Loss Voltage	280Vac±7V	
High Loss Return Voltage	270Vac±7V	
Max AC Input Voltage	300Vac	
Nominal Input Frequency	50Hz / 60Hz (Auto detection)	
Low Loss Frequency	40±1Hz	
Low Loss Return Frequency	42±1Hz	
High Loss Frequency	65±1Hz	
High Loss Return Frequency	63±1Hz	
Output Short Circuit Protection	Line mode: Circuit Breaker Battery mode: Electronic Circuits	
Efficiency (Line Mode)	>95% (Rated R load, battery full charged)	
Transfer Time	10ms typical (UPS); 20ms typical (Appliances)	
Output power derating: When AC input voltage drops to 95V or 170V depending on models, the output power will be derated.	230Vac model: 	

Table 2 Inverter Mode Specifications

INVERTER MODEL	HiS-3524	HiS-5548
Rated Output Power	3.5KVA/3.5KW	5.5KVA/5.5KW
Output Voltage Waveform	Pure Sine Wave	
Output Voltage Regulation	230Vac±5%	
Output Frequency	60Hz or 50Hz	
Peak Efficiency	94%	
Overload Protection	5s@≥150% load; 10s@110%~150% load	
Surge Capacity	2* rated power for 5 seconds	
Nominal DC Input Voltage	24Vdc	48Vdc
Cold Start Voltage	23.0Vdc	46.0Vdc
Low DC Warning Voltage		
@ load < 20%	22.0Vdc	44.0Vdc
@ 20% ≤ load < 50%	21.4Vdc	42.8Vdc
@ load ≥ 50%	20.2Vdc	40.4Vdc
Low DC Warning Return Voltage		
@ load < 20%	23.0Vdc	46.0Vdc
@ 20% ≤ load < 50%	22.4Vdc	44.8Vdc
@ load ≥ 50%	21.2Vdc	42.4Vdc
Low DC Cut-off Voltage		
@ load < 20%	21.0Vdc	42.0Vdc
@ 20% ≤ load < 50%	20.4Vdc	40.8Vdc
@ load ≥ 50%	19.2Vdc	38.4Vdc
High DC Recovery Voltage	29Vdc	58Vdc
High DC Cut-off Voltage	31Vdc	62Vdc
No Load Power Consumption	<25W	<50W
Saving Mode Power Consumption	<10W	<15W

Table 3 Charge Mode Specifications

Utility Charging Mode			
INVERTER MODEL	HiS-3524	HiS-5548	
Charging Current (UPS) @ Nominal Input Voltage	80A	80A	
Bulk Charging Voltage	Flooded Battery	29.2	58.4
	AGM / Gel Battery	28.2	56.4
Floating Charging Voltage	27Vdc	54Vdc	
Charging Algorithm	3-Step		
Charging Curve			

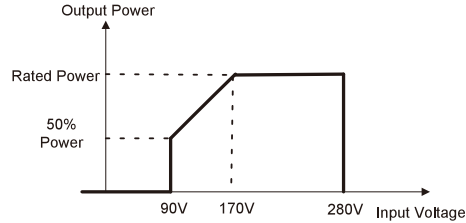
Solar Charging Mode		
INVERTER MODEL	HiS-3524	HiS-5548
Rated Power	5000W	6000W
PV Charge Current	110A	110A
Efficiency	98.0% max.	
Max. PV Array Open Circuit Voltage	500Vdc	500Vdc
PV Array MPPT Voltage Range	120-450Vdc	120-450Vdc
Min battery voltage for PV charge		
Standby Power Consumption	2W	
Battery Voltage Accuracy	+/-0.3%	
PV Voltage Accuracy	+/-2V	
Charging Algorithm	3-Step	

Table 4 General Specifications

INVERTER MODEL	HiS-3524	HiS-5548
Safety Certification	CE	
Operating Temperature Range	0°C to 55°C	
Storage temperature	-15°C~ 60°C	
Dimension (D*W*H), mm	472*297*133	
Net Weight, kg	9.5	10.5

TROUBLE SHOOTING

Problem	LCD/LED/Buzzer	Explanation / Possible cause	What to do
Unit shuts down automatically during startup process.	LCD/LEDs and buzzer will be active for 3 seconds and then complete off.	The battery voltage is too low (<1.91V/Cell)	1. Re-charge battery. 2. Replace battery.
No response after power on.	No indication.	1. The battery voltage is far too low. (<1.4V/Cell) 2. Battery polarity is connected reversed.	1. Check if batteries and the wiring are connected well. 2. Re-charge battery. 3. Replace battery.
Mains exist but the unit works in battery mode.	Input voltage is displayed as 0 on the LCD and green LED is flashing.	Input protector is tripped	Check if AC breaker is tripped and AC wiring is connected well.
	Green LED is flashing.	Insufficient quality of AC power. (Shore or Generator)	1. Check if AC wires are too thin and/or too long. 2. Check if generator (if applied) is working well or if input voltage range setting is correct. (UPS→Appliance)
	Green LED is flashing.	Set "Solar First" as the priority of output source.	Change output source priority to Utility first.
When the unit is turned on, internal relay is switched on and off repeatedly.	LCD display and LEDs are flashing	Battery is disconnected.	Check if battery wires are connected well.
Buzzer beeps continuously and red LED is on.	Fault code 07	Overload error. The inverter is overload 110% and time is up.	Reduce the connected load by switching off some equipment.
	Fault code 05	Output short circuited.	Check if wiring is connected well and remove abnormal load.
		Temperature of internal converter component is over 120°C.	Check whether the air flow of the unit is blocked or whether the ambient temperature is too high.
	Fault code 02	Internal temperature of inverter component is over 100°C.	
	Fault code 03	Battery is over-charged.	Return to repair center.
		The battery voltage is too high.	Check if spec and quantity of batteries are meet requirements.
	Fault code 01	Fan fault	Replace the fan.
	Fault code 06/58	Output abnormal (Inverter voltage below than 190Vac or is higher than 260Vac)	1. Reduce the connected load. 2. Return to repair center
	Fault code 08/09/53/57	Internal components failed.	Return to repair center.
	Fault code 51	Over current or surge.	Restart the unit, if the error happens again, please return to repair center.
	Fault code 52	Bus voltage is too low.	
Fault code 55	Output voltage is unbalanced.		
Fault code 56	Battery is not connected well or fuse is burnt.	If the battery is connected well, please return to repair center.	

Appendix: Approximate Back-up Time Table

Model	Load (W)	Backup Time @ 24Vdc 100Ah (min)	Backup Time @ 24Vdc 200Ah (min)
HiS-3524	300	449	1100
	600	222	525
	900	124	303
	1200	95	227
	1500	68	164
	1800	56	126
	2100	48	108
	2400	35	94
	2700	31	74
	3200	28	67

Model	Load (W)	Backup Time @ 48Vdc 100Ah (min)	Backup Time @ 48Vdc 200Ah (min)
HiS-5548	500	613	1288
	1000	268	613
	1500	158	402
	2000	111	271
	2500	90	215
	3200	76	182
	3500	65	141
	4000	50	112
	4500	44	100
	5000	40	90

Note: Backup time depends on the quality of the battery, age of battery and type of battery.
Specifications of batteries may vary depending on different manufacturers.

*** Product technical specifications are subject to change without notice.**